

THUMP 212 XT THUMP 215 XT

1400W Enhanced Powered Loudspeakers

OWNER'S MANUAL



Important Safety Instructions

1. Read these instructions.
2. Keep these instructions.
3. Heed all warnings.
4. Follow all instructions.
5. Do not use this apparatus near water.
6. Clean only with a dry cloth.
7. Do not block any ventilation openings. Install in accordance with the manufacturer's instructions.
8. Do not install near any heat sources such as radiators, heat registers, stoves, or other apparatus (including amplifiers) that produce heat.
9. Protect the power cord from being walked on or pinched particularly at plugs, convenience receptacles, and the point where they exit from the apparatus.
10. Only use attachments/accessories specified by the manufacturer.
11. Use only with a cart, stand, tripod, bracket, or table specified by the manufacturer, or sold with the apparatus. When a cart is used, use caution when moving the cart/apparatus combination to avoid injury from tip-over.
12. Unplug this apparatus during lightning storms or when unused for long periods of time.
13. Refer all servicing to qualified service personnel. Servicing is required when the apparatus has been damaged in any way, such as power-supply cord or plug is damaged, liquid has been spilled or objects have fallen into the apparatus, the apparatus has been exposed to rain or moisture, does not operate normally, or has been dropped.
14. This apparatus shall not be exposed to dripping or splashing, and no object filled with liquids, such as vases or beer glasses, shall be placed on the apparatus.
15. Do not overload wall outlets and extension cords as this can result in a risk of fire or electric shock.



CAUTION

RISK OF ELECTRIC SHOCK! DO NOT OPEN!

CAUTION: TO REDUCE THE RISK OF ELECTRIC SHOCK DO NOT REMOVE COVER (OR BACK). NO USER-SERVICEABLE PARTS INSIDE. REFER SERVICING TO QUALIFIED PERSONNEL.

The lightning flash with arrowhead symbol within an equilateral triangle is intended to alert the user to the presence of uninsulated "dangerous voltage" within the product's enclosure, that may be of significant magnitude to constitute a risk of electric shock to persons.

The exclamation point within an equilateral triangle is intended to alert the user of the presence of important operating and maintaining (servicing) instructions in the literature accompanying the appliance.

16. **NOTE:** This equipment has been tested and found to comply with the limits for a Class A digital device, pursuant to part 15 of the FCC Rules. These limits are designed to provide reasonable protection against harmful interference when the equipment is operated in a commercial environment. This equipment generates, uses, and can radiate radio frequency energy and, if not installed and used in accordance with the instruction manual, may cause harmful interference to radio communications. Operation of this equipment in a residential area is likely to cause harmful interference in which case the user will be required to correct the interference at his own expense.

WARNING: Operation of THUMP in a residential environment could cause radio interference.

CAUTION: Changes or modifications to this device not expressly approved by LOUD Audio, LLC could void the user's authority to operate the equipment under FCC rules.

17. This apparatus has been designed with Class-I construction and must be connected to a mains socket outlet with a protective earthing connection (the third grounding prong).
18. The MAINS plug or an appliance coupler is used as the disconnect device, so the disconnect device shall remain readily operable.
19. The equipment complies with FCC/IC RSS-102 radiation exposure limits set forth for an uncontrolled environment. The equipment should be installed and operated with minimum distance 20cm between the radiator & your body.
Cet appareil est conforme aux limites d'exposition aux radiations de la FCC/IC RSS-102 énoncées pour un environnement non contrôlé. Il doit être installé et utilisé avec une distance minimale de 20 cm entre le radiateur et votre corps.

20. The use of apparatus is in tropical and/or moderate climates.
21. The maximum ambient temperature during use of the appliance must not exceed 0–45° C // 32–113° F.
22. Operation frequency: 2400MHz – 2483.5MHz
23. RF POWER = <20dBm
24. This apparatus does not exceed the Class A/Class B (whichever is applicable) limits for radio noise emissions from digital apparatus as set out in the radio interference regulations of the Canadian Department of Communications. Canada ICES-003(A)/NMB-003(A)
ATTENTION — *Le présent appareil numérique n'émet pas de bruits radioélectriques dépassant les limites applicables aux appareils numériques de class A/de class B (selon le cas) prescrites dans le règlement sur le brouillage radioélectrique édicté par le ministre des communications du Canada.*
25. This device complies with Part 15 of the FCC Rules [and contains license-exempt transmitter(s)/receiver(s) that comply with Innovation, Science and Economic Development Canada's license-exempt RSS(s)]. Operation is subject to the following two conditions:
(1) this device may not cause harmful interference, and
(2) this device must accept any interference received, including interference that may cause undesired operation.
L'émetteur/récepteur exempt de licence contenu dans le présent appareil est conforme aux CNR d'Innovation, Sciences et Développement économique Canada applicables aux appareils radio exempts de licence. L'exploitation est autorisée aux deux conditions suivantes:
(1) *l'appareil ne doit pas produire de brouillage, et*
(2) *l'appareil doit accepter tout brouillage radioélectrique subi, même si le brouillage est susceptible d'en compromettre le fonctionnement.*
26. Exposure to extremely high noise levels may cause permanent hearing loss. Individuals vary considerably in susceptibility to noise-induced hearing loss, but nearly everyone will lose some hearing if exposed to sufficiently intense noise for a period of time. The U.S. Government's Occupational Safety and Health Administration (OSHA) has specified the permissible noise level exposures shown in the following chart.

According to OSHA, any exposure in excess of these permissible limits could result in some hearing loss. To ensure against potentially dangerous exposure to high sound pressure levels, it is recommended that all persons exposed to equipment capable of producing high sound pressure levels use hearing protectors while the equipment is in operation. Ear plugs or protectors in the ear canals or over the ears must be worn when operating the equipment in order to prevent permanent hearing loss if exposure is in excess of the limits set forth here:

Duration, per day in hours	Sound Level dBA, Slow Response	Typical Example
8	90	Duo in small club
6	92	
4	95	Subway Train
3	97	
2	100	Very loud classical music
1.5	102	
1	105	Ty screaming at Troy about deadlines
0.5	110	
0.25 or less	115	Loudest parts at a rock concert

WARNING — To reduce the risk of fire or electric shock, do not expose this apparatus to rain or moisture.

CAUTION — To prevent electric shock hazard, do not connect to mains power supply while grille is removed.

Laite on liitettävä suojakoskettimilla varustettuun pistorasiaan.

Apparatet stikprop skal tilsluttes en stikkontakt med jord, som giver forbindelse til stikproppens jord.

Apparatet må tilkoples jordet stikkontakt.

Apparaten skall anslutas till jordat uttag.

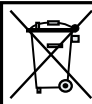

Correct disposal of this product: This symbol indicates that this product should not be disposed of with your household waste, according to the WEEE directive (2012/19/EU) and your national law. This product should be handed over to an authorized collection site for recycling waste electrical and electronic equipment (EEE). Improper handling of this type of waste could have a possible negative impact on the environment and human health due to potentially hazardous substances that are generally associated with EEE. At the same time, your cooperation in the correct disposal of this product will contribute to the effective usage of natural resources. For more information about where you can drop off your waste equipment for recycling, please contact your local city office, waste authority, or your household waste disposal service.

Contents

- Important Safety Instructions 2
- Contents / Features 3
- Introduction / Getting Started 4
- Hookup Diagrams 5

- ThumpXT Loudspeakers: Rear Features..... 10
 - 1. Power Connection 10
 - 2. Power Switch 10
 - 3. XLR and 1/4" Combo Input Jacks..... 10
 - 4. 1/8" Input Jack [Ch. 2] 11
 - 5. Mic / Line Switch [Ch. 1] 11
 - 6. Gain Knobs 11
 - 7. Thru Jack..... 11
 - 8. Main Volume Knob..... 11
 - 9. Voicing Modes 12
 - 10. Outdoor Mode 12
 - 11. Music Ducking 12
 - 12. Feedback Eliminator 12
 - 13. Front LED 12
 - 14. Fan On / Off..... 13
 - 15. Fan Speed 13
 - 16. Mist Level 13
 - 17. Heat On / Off 13
 - 18. Heat Level..... 13
 - 19. Rotate 13
 - 20. Bluetooth / Pair 14
 - 21. Speaker Link 14
 - 22. Overload LED 15
- Factory Reset 15

- Protection Circuitry..... 16
 - Limiting..... 16
 - Overexcursion Protection 16
 - Thermal Protection..... 16
- AC Power 16
- Care and Maintenance 16

- Placement / Room Acoustics 17
- Rigging..... 18

- Appendix A: Service Information..... 19
- Appendix B: Technical Information 20
- ThumpXT Dimensions 21
- ThumpXT Block Diagram 22
- Limited Warranty 23

Features

1400W ultra-efficient Class-D amplifier

Built-Like-A-Tank™ to conquer every gig while lightweight for easy loading

**Frequency response: 47 Hz – 20 kHz [Thump212XT]
 Frequency response: 40 Hz – 20 kHz [Thump215XT]**

**Max SPL: 128 dB [Thump212XT]
 Max SPL: 129 dB [Thump215XT]**

**12" high-performance woofer [Thump212XT]
 15" high-performance woofer [Thump215XT]**

1" compression driver

4 Application-specific voicing modes

- Music
- Live
- Club
- Monitor

Outdoor mode optimizes voicing for open air venues

Bluetooth® connectivity for streaming, speaker linking, and control

- Download the Thump Connect 2 app for complete wireless control
- Link 2 ThumpXT loudspeakers for a powerful, wireless, music playback system in both stereo and dual-zone configuration

Flexible I/O

- Ch.1 features an XLR/TRS input that accepts mic or line signals
- Ch.2 features an XLR/TRS line input plus stereo 1/8" input
- Thru output contains audio from both input channels

Built-in Feedback Eliminator reduces squeals and out of control rumble

Music Ducking mode automatically reduces the level of Ch. 2 when Ch. 1 receives signal

Front LED On/Off switch

Universal Power Supply (100-240VAC)

Standard pole mount

M10 flypoints for permanent install

Monitor wedge provides optimal angle for use as a floor monitor

Weight

**27.6 lb / 12.5 kg [Thump212XT]
 32.6 lb / 14.8 kg [Thump215XT]**

Dimensions:

**24.4 x 14.0 x 14.0 in / 620 x 356 x 356 mm [Thump212XT]
 27.4 x 17.3 x 14.0 in / 696 x 439 x 356 mm [Thump215XT]**



Introduction

ThumpXT Loudspeakers are the next evolution of the incredibly popular series, packed with more power, capability, and bang-for-the-buck than ever before.

Completely redesigned from the ground up, ThumpXT features heavy-duty drivers, 1400W amplifiers, and powerful tools to make your next gig easier than ever.

Optimize the system with venue-specific voicing modes plus Indoor/Outdoor modes. The built-in Feedback Eliminator and Music Ducking mode keep the show running smooth when it counts.

Control it all plus access additional features like system EQ, levels, mutes, and more right from your phone with the Thump Connect 2 app. And with Bluetooth® streaming, ultra-versatile I/O, legendary Thump sound quality, and easy portability, ThumpXT is going to be your new favorite loudspeaker.

How to Use This Manual:

After this introduction, a getting started guide will help you get things set up fast. The hookup diagrams show some typical ThumpXT loudspeaker setups.



This icon marks information that is critically important or unique! For your own good, read and remember them...it is a good idea to pay special attention to these areas in the Owner's Manual marked with the "VERY IMPORTANT" hand icon.



There's an illustration of a microscope, so, of course, you're going to get more detailed information when you see this little guy. There are explanations of features and practical tips listed here.



It's a good idea to pay attention to text displayed next to a note icon, as this icon draws attention to certain features and functions relating to the usage of the ThumpXT Series.

Please write the serial numbers here for future reference (i.e., insurance claims, tech support, return authorization, make dad proud, etc.)

Purchased at:

Date of purchase:

Getting Started

The following steps will help you set up the loudspeakers quickly.

1. Make all initial connections with the power switches OFF on all equipment. Make sure the master volume, level and gain controls are all the way down.
2. If not using a subwoofer, connect the outputs from the mixing console (or other signal source) to the inputs on the rear panel of the loudspeakers.
3. If using a subwoofer, connect the outputs from the mixing console (or other signal source) to the inputs on the subwoofer, then connect the high pass outputs from the subwoofer to the inputs of the loudspeakers.
4. Push the line cord securely into the subwoofer's / loudspeaker's IEC connectors and plug the other ends into grounded AC outlets. The subwoofer/loudspeaker may accept the appropriate voltage as indicated near the IEC connector.
5. Go to the batting cages and work on your swing.
6. Turn the mixer (or other signal source) on.
7. Turn the subwoofer on (if applicable).
8. Turn the loudspeakers on.
9. Make sure the loudspeaker's channel gain knob(s) are set to mic or line.
10. Be sure that the volume of the input is the same as it would be during normal use.
11. Start the signal source and raise the mixer's main L/R fader up to a comfortably loud listening level.

Things to Remember:

- Never listen to loud music for prolonged periods. Please see the Safety Instructions on page 2 for information on hearing protection.
- As a general guide, the mixer (or other signal source) should be turned on first, subwoofers next, and ThumpXT loudspeakers last. As such, the ThumpXT loudspeakers should also be turned off first, followed by the subwoofers, then the mixer. This will reduce the possibility of any turn-on or turn-off thumps and other noises generated by any upstream equipment from coming out of the speakers.
- Save the shipping boxes and packing materials! You may need them someday. Besides, the cats will love playing in them and jumping out at you unexpectedly. Remember to pretend like you are surprised!
- Save your sales receipt in a safe place.

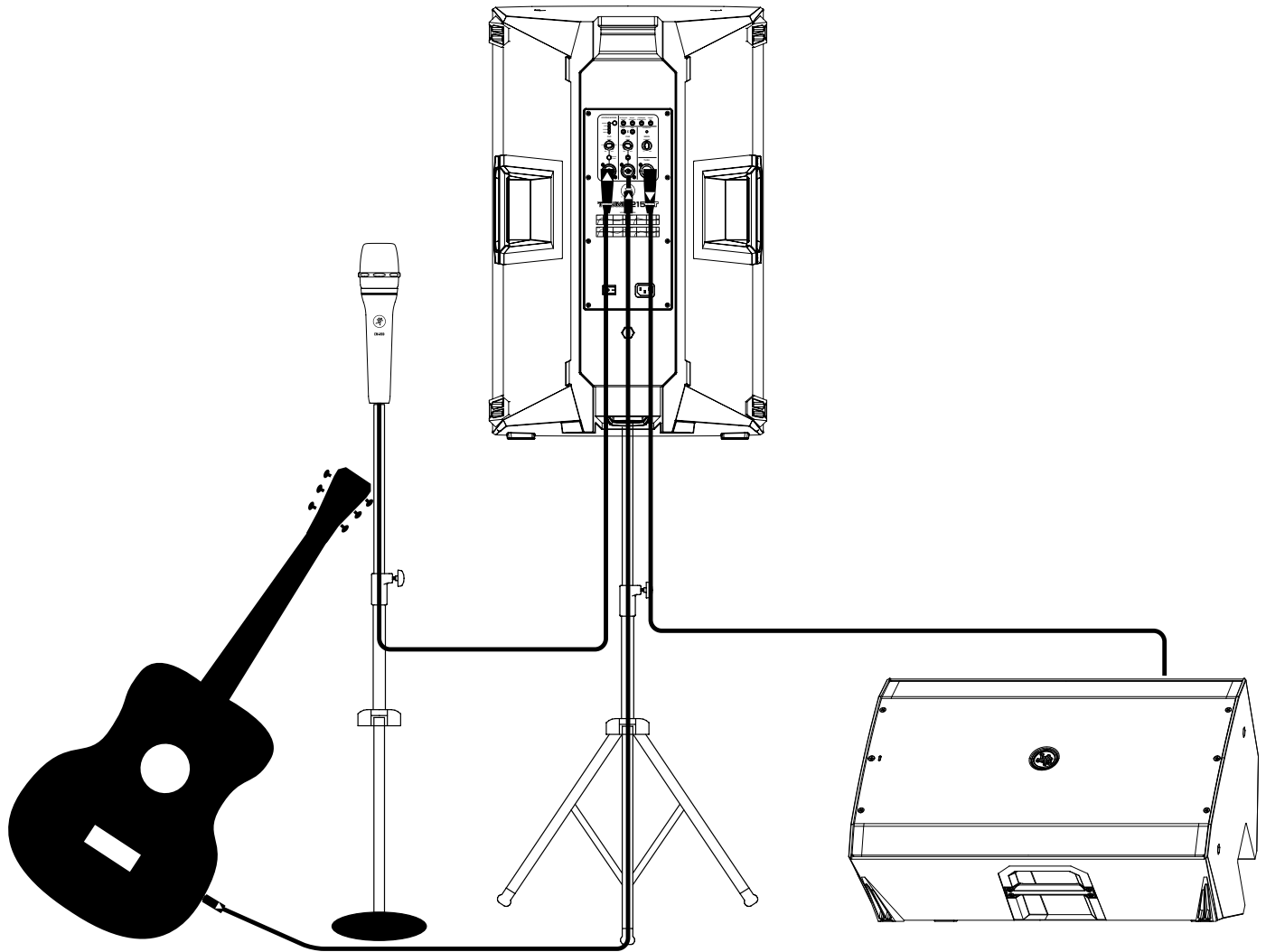

ThumpXT loudspeakers are the perfect tool for singer-songwriters touring the local coffee shops. Bring your favorite axe and mic, ThumpXT loudspeakers and cables and power cords.

In this example, a Mackie EM-89D microphone is connected to the channel 1 input of a ThumpXT loudspeaker, used as the main PA. The Channel 1 gain knob should be set to Mic. The Mic/Line switch should be ENGAGED [Mic], as well. Lastly, set the voicing mode to live.

Now grab your axe and plug it directly into the channel 2 input. Or if you use effects, connect the guitar to the effects input and another cable from the effects output to the channel 2 input. Note that the gain knob is set to Line.

An additional ThumpXT loudspeaker will be used for monitoring purposes. Simply connect a cable from the ThumpXT PA's THRU jack to the ThumpXT monitor's channel 1 input. This gain knob should also be set to Line and the voicing mode set to monitor.

Keep in mind that these "MIC" and "LINE" markings are for reference only and may need to be raised or lowered.

Singer-Songwriter Setup

Hookup Diagrams continued...

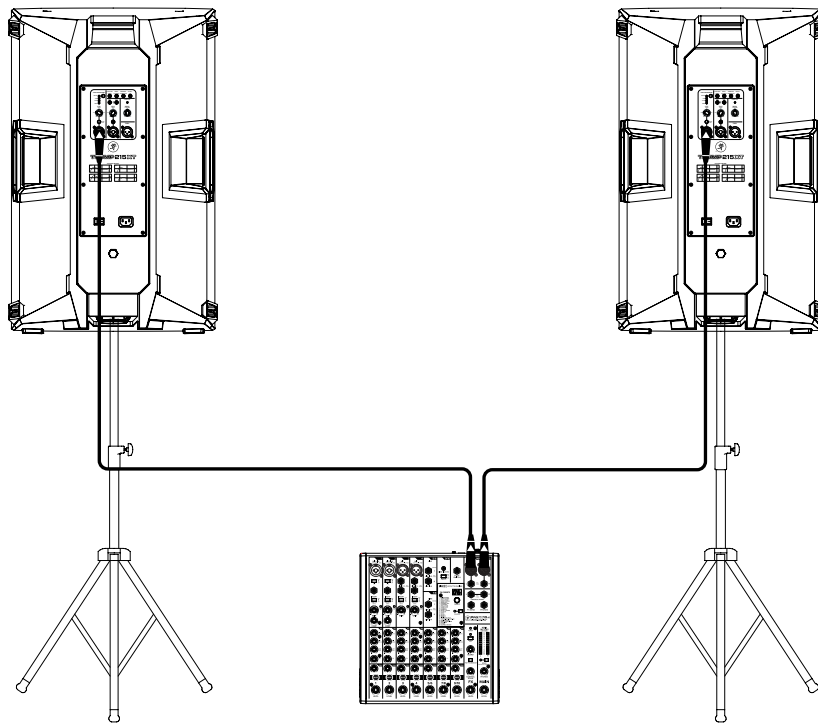

In this example, a ProFX10v3 mixer is connected directly to two Thump215XT loudspeakers. It is the perfect setup for a small club or... a fun karaoke house party! Simply connect the L/R outputs of the ProFX10v3 mixer to the channel 1 input of each ThumpXT loudspeaker. Set the voicing mode of both to live or club. The gain knob on both should be set to Line. The Mic/Line switches should be disengaged [Line], as well. Keep in mind that these “MIC” and “LINE” markings are for reference only and may need to be raised or lowered.

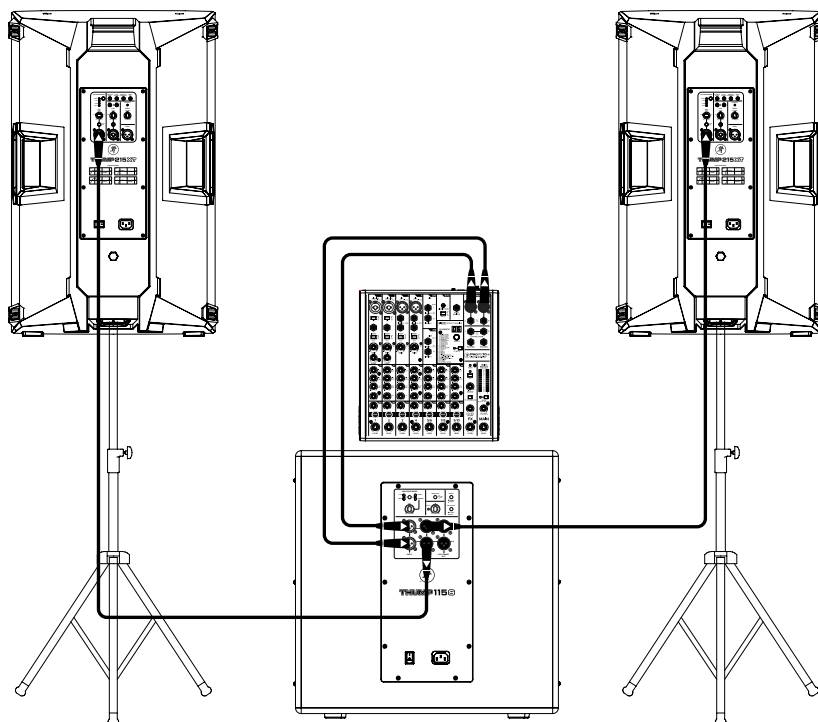

If you desire a little more boom, add a Thump subwoofer to the mix. Here, the L/R outputs of a ProFX10v3 mixer are connected directly to the A and B inputs of a Thump115S subwoofer. Then the High-Pass Outs of the subwoofer are connected to the channel 1 inputs of a pair of Thump215XT loudspeakers. Set the high pass mode of the sub to your preferred choice and the voicing mode of both loudspeakers to live or club. The gain knob on both should be set to Line. Keep in mind that these “MIC” and “LINE” markings are for reference only and may need to be raised or lowered.

Small Club System

Hookup Diagrams continued...

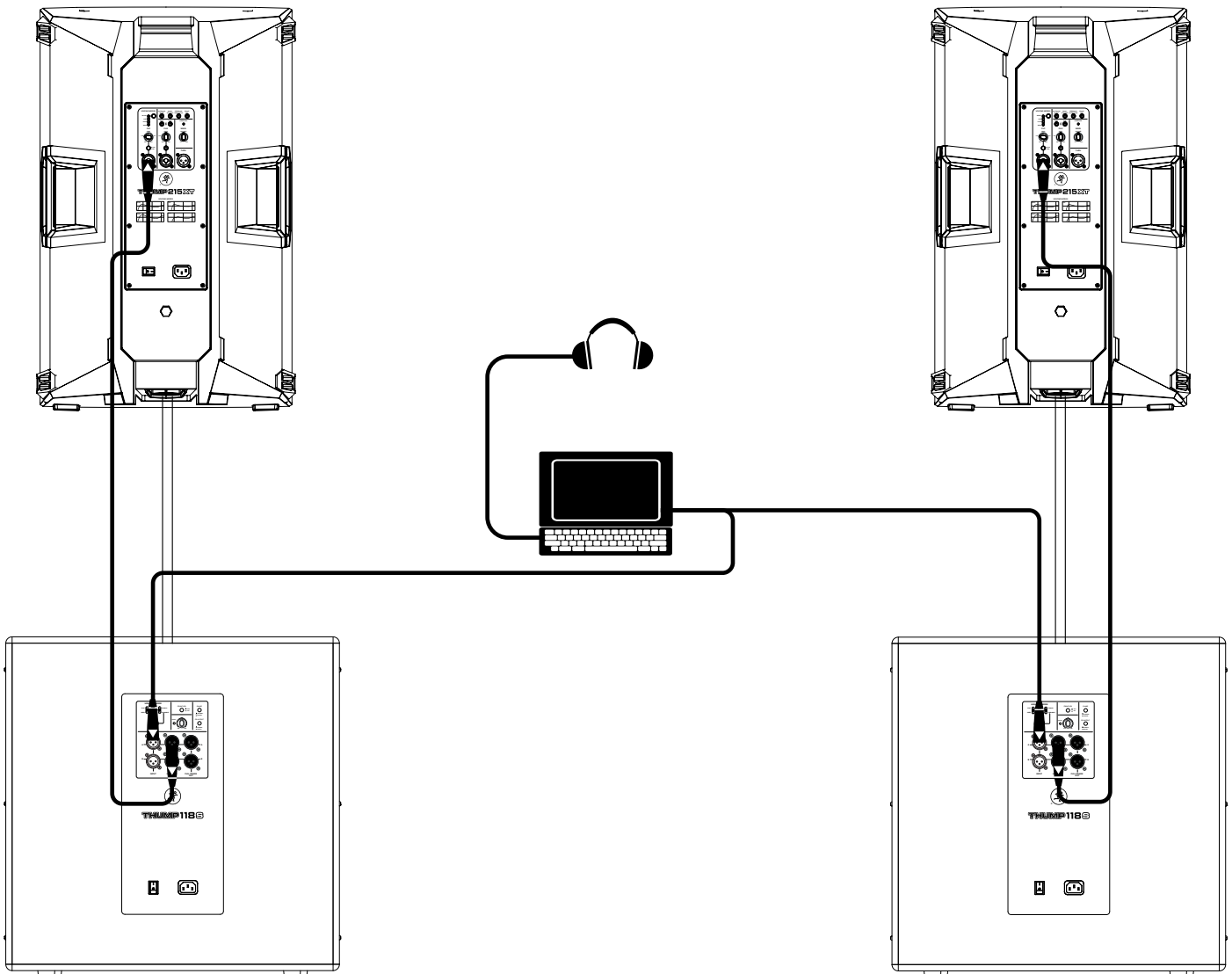

Perhaps you're a DJ playing bumpin' tunes in the middle of the night to a crowd that's groovin' and dancin' to your fine selection.

In this example, a laptop is connected to the inputs of two Thump118S subwoofers.

The High-Pass Out of each subwoofer is then connected to the input of each Thump215XT loudspeaker. Additionally, a set of Mackie MC-450 headphones is connected to the phones jack of the laptop.

The gain knob on both loudspeakers should be set to Line. The Mic/Line switches should be disengaged [Line], as well. Additionally, set the high pass mode of the sub to your preferred choice and the voicing mode of both loudspeakers to live or club. Keep in mind that these "MIC" and "LINE" markings are for reference only and may need to be raised or lowered.

Hookup Diagrams continued...

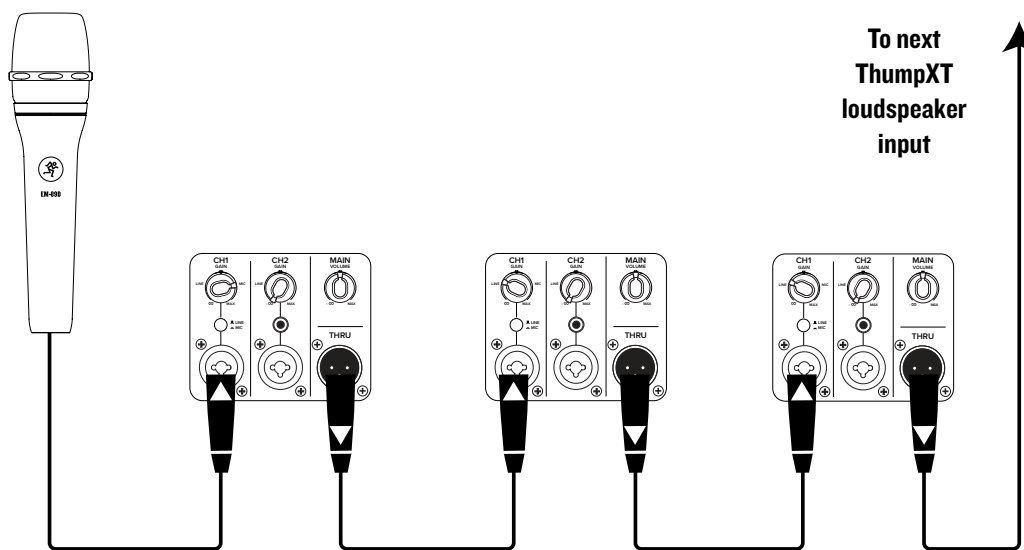
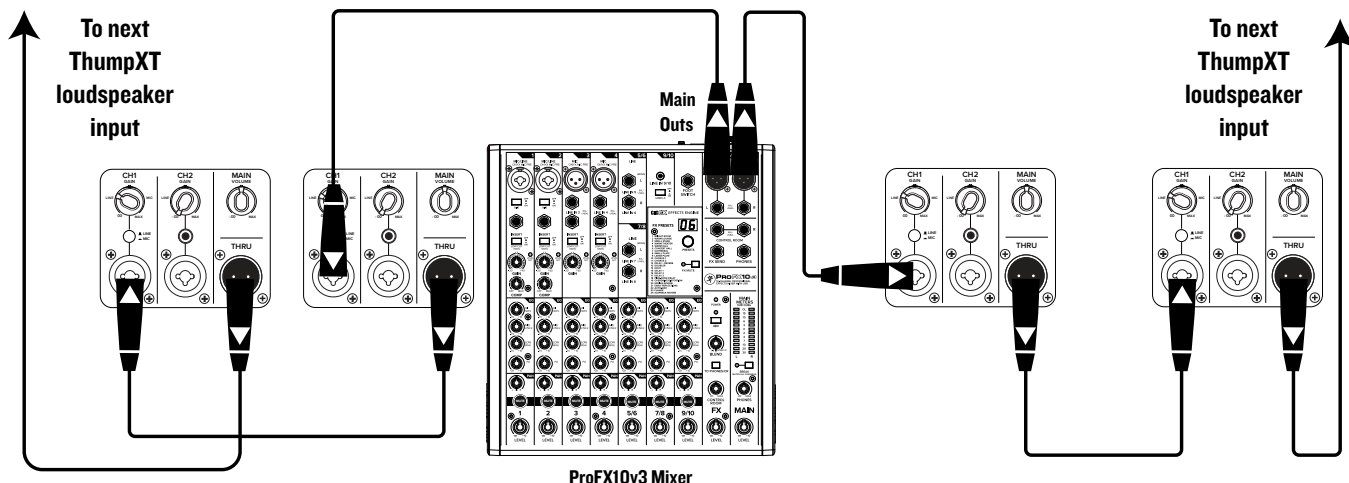

ThumpXT loudspeakers may be daisy-chained via the “THRU” jack which outputs all inputs. Simply plug the signal source (i.e., mixer output or microphone) into the input jack(s), and patch that loudspeaker’s mix out jack to the next loudspeaker’s input jack, and so on, daisy-chaining multiple ThumpXT loudspeakers. See above for visual representations of daisy-chaining.

NOTE: Make sure to set the gain knob(s) correctly. In the top diagram, all input channels are set to “LINE” and in the bottom diagram, input channel 1 of the first ThumpXT is set to “MIC”, but the remaining ones should be set to “LINE”. Keep in mind that these “MIC” and “LINE” markings are for reference only and may need to be raised or lowered.

Daisy-Chaining Multiple ThumpXT Loudspeakers

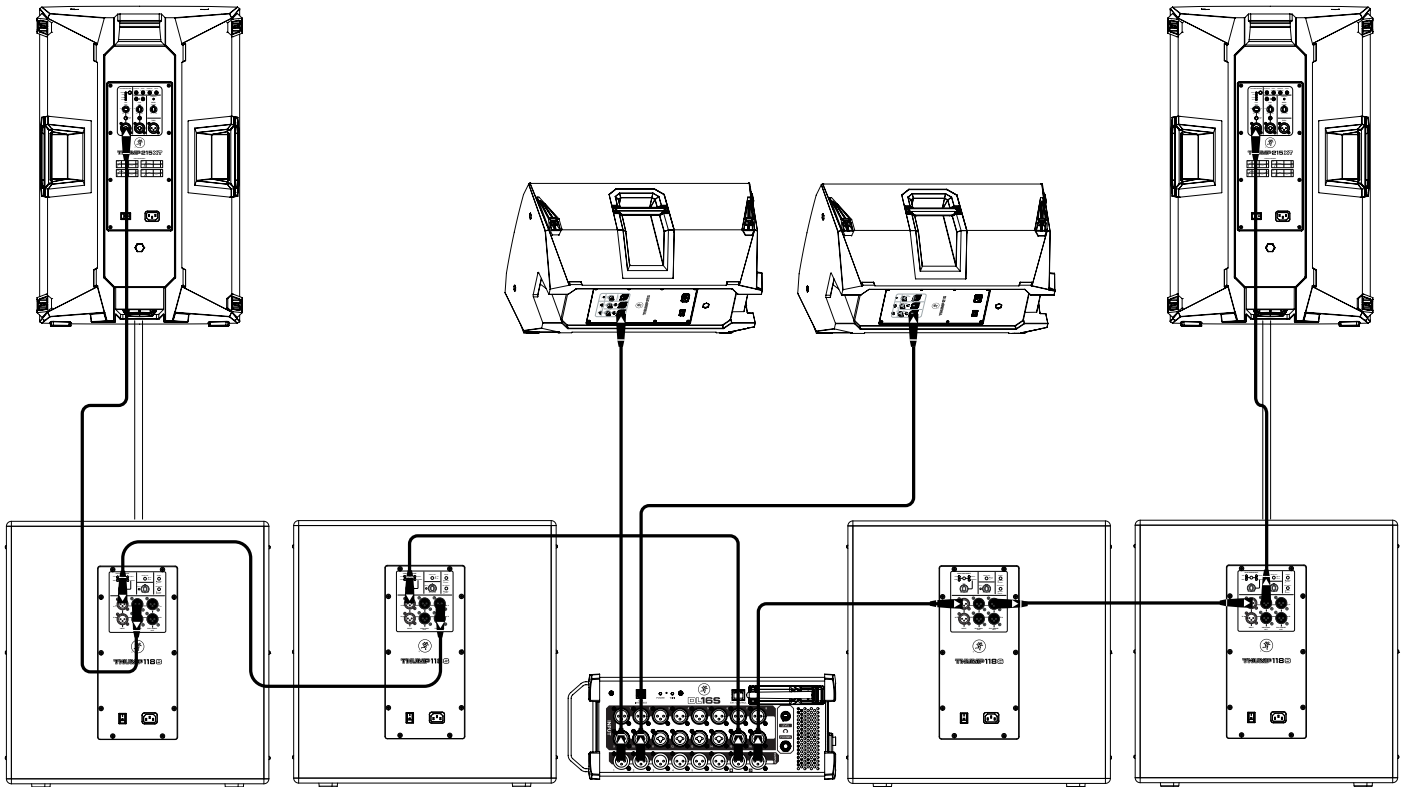

Here's how to set up a large club system. In this example, the L/R outputs of a DL16S mixer are connected directly to the channel A inputs of a pair of Thump118S subwoofers. The Full Range Out of each subwoofer is then connected to the inputs of an additional pair of Thump118S subwoofers.

From here, the High Pass Out of the two outer Thump118S subwoofers are connected directly to the inputs of a set of Thump215XT loudspeakers. Then set the subwoofer's High Pass Mode to Deep and the voicing mode of both loudspeakers to live or club. Talk about beefy low end!

Outputs 1 and 2 from the mixer may be used as aux sends; these are connected directly to the channel 1 inputs of a pair of Thump215 loudspeakers to be used as monitors for the band. The gain knob on all Thump loudspeakers in this example should be set to Line. Lastly, all Mic/Line switches should be disengaged [Line]. Keep in mind that these "MIC" and "LINE" markings are for reference only and may need to be raised or lowered.

Large Club System

ThumpXT Series Loudspeakers: Rear Panel Features

1. Power Connection

This is a standard 3-prong IEC power connector. Connect the detachable power cord (included in the packaging with the loudspeaker) to the power receptacle, and plug the other end of the power cord into an AC outlet.



Make sure that the AC power is matched to the AC power indicated on the rear panel (near the IEC receptacle).



Disconnecting the plug's ground pin is dangerous. Don't do it!

2. Power Switch

Press the right side of this rocker switch inwards to turn on the loudspeaker. Press the left side of this rocker switch inwards to turn off the loudspeaker.



As a general guide, the mixer (or other signal source) should be turned on first, subwoofers next, and loudspeakers last.

As such, the loudspeakers should also be turned off first, followed by the subwoofers, then the mixer. This will reduce the possibility of any turn-on or turn-off thumps and other noises generated by any upstream equipment from coming out of the speakers.

3. XLR and 1/4" Combo Input Jacks

Input channels 1 and 2 may accept a balanced mic signal using an XLR connector. They are wired as follows, according to standards specified by the AES (Audio Engineering Society).

XLR Balanced Wiring:

- Pin 1 = Shield (ground)
- Pin 2 = Positive (+ or hot)
- Pin 3 = Negative (- or cold)

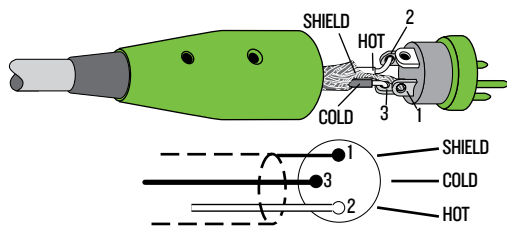

In addition to accepting a balanced mic signal using an XLR connector, these input channels may also accept 1/4" line-level signals driven by balanced or unbalanced sources.

To connect balanced lines to these inputs, use a 1/4" Tip-Ring-Sleeve (TRS) plug. "TRS" stands for Tip-Ring-Sleeve, the three connection points available on a stereo 1/4" or balanced phone jack or plug. TRS jacks and plugs are used for balanced signals and are wired as follows:

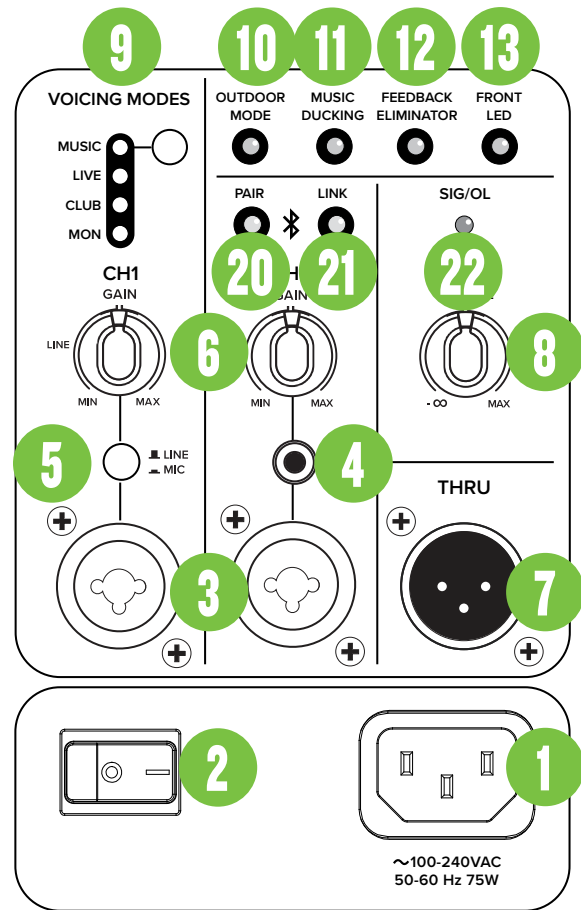

1/4" TRS Balanced Mono Wiring:

- Sleeve = Shield
- Tip = Hot (+)
- Ring = Cold (-)

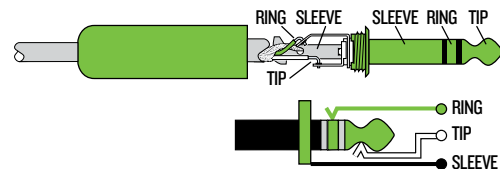

To connect unbalanced lines to these inputs, use a 1/4" mono (TS) phone plug, wired as follows:

1/4" TS Unbalanced Mono Wiring:

- Sleeve = Shield
- Tip = Hot (+)

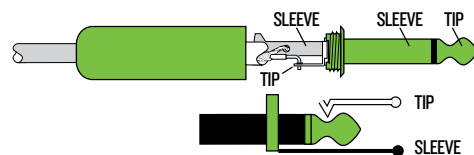

NEVER connect the output of an amplifier directly to a ThumpXT input jack. This could damage the input circuitry!

ThumpXT Series Loudspeakers: Rear Panel Features continued...

4. 1/8" Input Jack [Ch. 2]

This input channel may accept an 1/8" line-level signal from a phone, tablet, MP3 player, or other signal source.



NEVER connect the output of an amplifier directly to a ThumpXT input jack. This could damage the input circuitry.



The 1/8" line-level connection may be used simultaneously with channel 2's combo jack – XLR or 1/4" – and/or Bluetooth connection. In other words, if there is a physical connection to the 1/8" line input, another physical connection to the combo jack **AND** a device is connected via Bluetooth, none of those inputs will be interrupted. An easy way to look at it is... there are extra inputs! The 1/8" line-level connection and XLR (or 1/4") connection sum together and do not override each other.

5. Mic / Line Switch [Ch. 1]

Because an XLR connector may be connected to a mic or an instrument, this switch adjusts the channel's input sensitivity to optimize channel 1 for mic or line-level signals. If a mic is connected, this switch should be engaged and the gain knob – more below – set to mic. If an instrument is connected to channel 1 (via XLR), this switch should be disengaged and the gain knob set to line.

6. Gain Knobs [Ch. 1 and 2]

If you haven't already, please read the "Quick Start" section on page 4. Setting the gain correctly will ensure that the preamplifier's gain is not too high, where distortion could occur, and not too low, where the quieter, exquisitely-delicate passages might be lost in background noise.

The gain knobs allow signals from the outside world to be adjusted to run through each channel at optimal internal operating levels.

If connecting mixer outputs to ThumpXT inputs, set the gain knobs to 9:00 ["LINE"] for optimal sound and performance.



Keep in mind that these "MIC" and "LINE" markings are for reference only and may need to be raised or lower.

7. Thru Jack

This is a male XLR-type connector that produces the mix from the input jacks. Use it to daisy-chain several ThumpXT loudspeakers together off the same signal source(s).

They are wired as follows, according to standards specified by the AES (Audio Engineering Society):

Balanced XLR Output Connector

- Pin 1 – Shield (ground)
- Pin 2 – Positive (+ or hot)
- Pin 3 – Negative (- or cold)

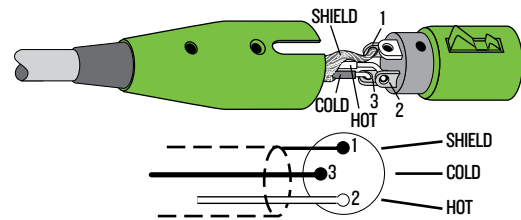

See page 8 to learn more about daisy-chaining ThumpXT loudspeakers.

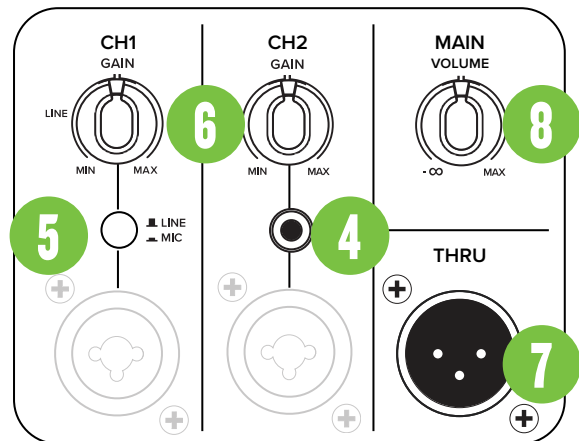

8. Main Volume Knob

The volume knob adjusts the overall signal level at the input to the built-in power amplifiers. It ranges from Off ($-\infty$) to MAX (maximum gain).

- Thump loudspeakers are designed to operate with a +10 dBu signal when all knobs are at the center position.

- Thump loudspeakers may accept up to a +20 dBu signal by turning down the channel gain in line mode.

- Turning the main knob past center position will provide enough gain to connect a microphone directly. Most microphones will want the knob somewhere around the 9:00 position. For safety, if you're plugging in a mic, start with the volume off and gradually rotate it clockwise until you achieve the desired volume... and be on the lookout for the dreaded shriek of the feedback monster.

ThumpXT Series Loudspeakers: Rear Panel Features continued...

9. Voicing Modes

The voicing mode allows you to change the ThumpXT's voicing to tailor it to best suit your particular application. Press the voicing mode button repeatedly until the LED of the voicing mode you desire is illuminated.

The four voicing modes are as follows:

- **MUSIC Voicing Mode** – This plug-and-play mode is perfect for listening to mastered music and is optimized to maintain tonal balance at peak output volume.
- **LIVE Voicing Mode** – This mode works well for singer-songwriters, as it features an upper bass parametric scoop to reduce unwanted low frequency color and adds boost to upper mid-range and high frequencies.
- **CLUB Voicing Mode** – This mode is full range, but focuses on increased bass and brilliant high frequencies. This is the place to start for most DJ / music playback applications.
- **MONITOR Voicing Mode** – Monitor mode was tailored to reduce excess low frequency output when coupled with the ground, while also reducing mid-range bite for the artist(s).

NOTE This mode should only be engaged when the speaker is in its monitor orientation on a stage or floor... if not, the low-end will sound very lean.

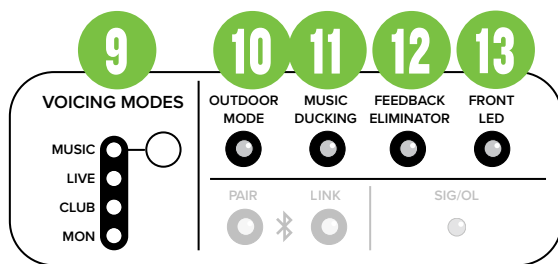

10. Outdoor Mode

Regarding outdoor mode... in a sentence, choose whether you are using ThumpXT inside or outside. The speaker's voicing is altered to the environment. That's all you need to know, but we're going to give you more!

When speakers are outside, a combination of low and high frequencies don't build up the way they do inside. ThumpXT corrects for that by boosting the frequency ranges that become deficient so the speaker sounds the same outside as when it's inside. You make the selection, we'll do the rest!

The outdoor mode LED will illuminate green when engaged (outdoors).

11. Music Ducking

Have you been to an event where music was playing, then when someone spoke into the mic, that the music volume decreased greatly (but was still there)? That's called "music ducking"!

When the music ducking switch is engaged, the channel 2 level will decrease when a mic signal is present on channel 1. Additionally, the LED will illuminate green. As if by magic, once the speaking is completed, the music will return back to its previous level. True wizards, those engineers... and none of them have long grey beards, robes and pointy hats.

NOTE The audio nerds out there might like to know that the channel 2 level decreases by 10 dBu when a mic signal is present in channel 1 (and when auto-ducking is engaged, of course).

12. Feedback Eliminator

The multi-band feedback eliminator hunts down offending feedback frequencies and applies up to six notch filters automatically to destroy feedback and maximize gain prior to feedback. This is a great tool for when an engineer is not present.

• **Off [Default]** – The feedback eliminator is not engaged. If filters have been applied, this setting will retain its current filter settings if there are any, but they will not be engaged until it is turned back on.

• **On** – When the automatic feedback eliminator is turned on, scanning occurs continuously. The six filters will engage sequentially when feedback is present until all are used and then it will be locked. If feedback is identified on an existing filter, the notch will deepen in three steps to further destroy the offending feedback frequency. Pretty cool, huh?! The LED will illuminate green when engaged.

NOTE The feedback eliminator **ONLY** affects channel 1 (mic and line mode).



When two ThumpXT loudspeakers are linked together in stereo mode, the feedback eliminator should only be engaged on the primary ThumpXT.

13. Front LED

There is a single horizontal LED located near the bottom-front of each ThumpXT. This LED illuminates green when the front LED switch is engaged. Additionally, the switch's LED will illuminate green. Disengage the switch if you do not want the front panel LED to illuminate. We like to call this 'stealth' mode.

ThumpXT Series Loudspeakers: Rear Panel Features continued...

14. Fan On / Off

One of our favorite things about the Thump Series is the Summer cool-off / Winter warm-up feature. Is it hotter than the blazes out where you are? We've got you covered!

Simply press this switch to turn the fan on and off. The speaker begins acting like a fan, blowing out cool air!

The LED will illuminate green when engaged (fan on).

15. Fan Speed

Want more? Of course you do! Here you're able to select the speed setting of the fan from 1 (the lowest setting) to 5 (the highest setting).

Quickly press this button to what setting you would like, up to five times. The LED will flash green the number of the current setting.

16. Mist Level

A rotating fan with multiple speeds is a nice feature, but when a mister is thrown in...? Oh, all bets are off!

When the mist level switch is engaged, a light spray of water is dispersed to keep the band and crowd nice and refreshed throughout the performance. The LED will illuminate green when engaged (mist on).

17. Heat On / Off

The fan feature is nice... but what if it's 40° below with 20 feet of snow outside and a wind chill factor of the frozen tundra? Yeah, we've got you covered there, too!

The built-in heater is great, especially when in the monitor position. Gotta love warm tootsies! Just like with the fan, simply press this switch to turn the heat on and off. The LED will illuminate green when engaged (heat on).

18. Heat Level

If the temperature is the aforementioned "frigid", we're pretty confident that you're going to want to crank the heat... perhaps not, but we'd bet on it!

This works similarly to that of the fan speed with settings ranging from 1 (low heat) to 5 (cranked heat). Quickly press this button to what setting you would like, up to five times. The LED will flash green the number of the current setting.

19. Rotate

Last, but absolutely not least... the fan AND heater are both rotatable (although the one switch controls whichever one is engaged, of course).

The rotation speed may be set to 1 (low), 2 (medium), or 3 (high). As with the fan speed and heat level, quickly press this button to what setting you would like, up to three times. The LED will flash green the number of the current setting.

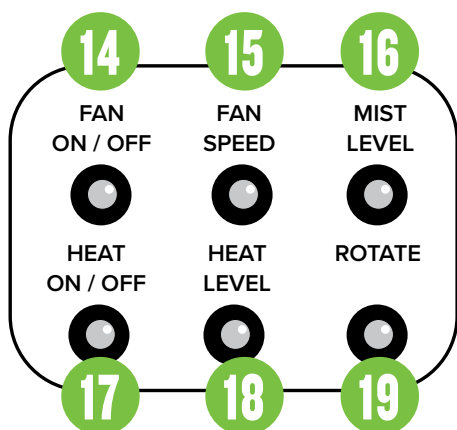

Please note that the rotation function only works when the loudspeaker is mounted on the T100 tripod or SPM400 pole mount. Operators are standing by!

ThumpXT Series Loudspeakers: Rear Panel Features continued...

20. Bluetooth / Pair

While not a “physical” connection, stereo channel 3/4 is considered the Bluetooth channel and its volume is raised and lowered via the device.

This is how to connect your device to the ThumpXT via Bluetooth! Read on...

Upon powering up the ThumpXT, the Bluetooth function is either:

- (1) In sleep mode. See ‘Pairing and connecting for the first time’ (to the right) or...
- (2) ...Paired and connected. See ‘Previously paired and connected devices’ (also to the right).

Pairing and connecting for the first time:

To enter pairing mode, press and hold the pair switch down for at least three seconds. The LED will illuminate and slow flash blue for approximately 30 seconds while in pairing mode. [The LED will continue to flash until it has successfully paired and connected].

While ThumpXT is in pairing mode, simultaneously scan for Bluetooth devices on your device. You should see ThumpXT appear in the list of “available devices”. Select it by tapping it. From there, your Bluetooth device should indicate that it is successfully connected. Additionally, the pair button will stop flashing and remain solid blue. If it does not, start the pairing process again, and make sure that ThumpXT and your device are both in pairing mode at the same time.

Previously paired and connected devices:

The Bluetooth connection will disconnect if it’s out of range or if ThumpXT is powered off. Previously paired and connected devices will automatically reconnect (unless turned off via the Thump Connect 2 App) and the pair button will once again illuminate a brilliant blue.



To drop the device from being paired with the ThumpXT, press and hold the ‘Bluetooth Pair’ button down for at least three seconds.



The Bluetooth connection may disconnect when affected by electrostatic discharge (ESD) or electrical fast transients (EFT). If this occurs, manually reconnect the Bluetooth connection.



As mentioned earlier, a Bluetooth connection may be used simultaneously with the combo jacks – XLR or 1/4” – and/or 1/8” line-level connection. In other words, if there is a physical connection to the 1/8” line input, another physical connection to the combo jack AND a device is connected via Bluetooth, none of those inputs will be interrupted. An easy way to look at it is... there are extra inputs!



If a phone – or two different phones – have been paired via Bluetooth with two ThumpXT loudspeakers, they will not link.

The options are either (1) one phone connected via Bluetooth and ThumpXT loudspeakers may be linked or (2) two phones connected via Bluetooth to two different ThumpXT loudspeakers and they may be not be linked.

21. Speaker Link

Two ThumpXT loudspeakers may either be linked together or separate (i.e. not linked). Additionally, there are options when linked, as they support stereo and zone (dual mono) linking. However, those features are only available when connected to the Thump Connect 2 App. It will default to stereo with just the hardware.

To link:

In order to link two ThumpXT loudspeakers, press and hold the ‘Link’ switch down on the primary ThumpXT loudspeaker until the blue LED begins slow-flashing.

Within (approximately) 30 seconds, a quick press and release of the ‘Link’ button on the secondary ThumpXT allows both units to “see” each other, handshake and link. The LEDs on both units will stop flashing and remain solid, indicating great success!



The ThumpXT loudspeakers will continue to auto-link on every power-up unless this feature is turned off via the Thump Connect 2 App.

To unlink:

In order to unlink the two ThumpXT loudspeakers, press and hold the ‘Link’ momentary switch / LED down on one of the ThumpXT loudspeakers until the blue LED turns off. The other ThumpXT will automatically unlink and the LEDs on both units will turn off.



If a phone – or two different phones – have been paired via Bluetooth with two ThumpXT loudspeakers, they will not link. The options are either (1) one phone connected via Bluetooth and ThumpXT loudspeakers may be linked or (2) two phones connected via Bluetooth to two different ThumpXT loudspeakers and they may be not be linked.

22. Sig/OL LED

This dual-colored LED will illuminate green when the input signal is present, indicating signal.

Thump loudspeakers have a built-in limiter that helps to prevent the amplifier outputs from clipping or overdriving the transducers. The LED illuminates red when the limiter is activated. It's okay for it to blink red occasionally, but if it blinks frequently or lights continuously, turn down the gain knob until it only blinks occasionally.



Excessive limiting may lead to overheating, which in turn trips the thermal protect circuitry and interrupts the performance. See 'Thermal Protection' on page 16 for more information.

Final Thoughts

Just a few final thoughts before we dive into a little more boring "techy"-type stuff. For starters, we would like to remind you once again that ThumpXT works great on its own, but when paired and connected with a device using the Thump Connect 2 app, your world of possibilities really opens up!

Factory Reset

Let's also talk factory resets. Since settings may be changed via Thump Connect 2, it may be necessary to reset the ThumpXT to its factory settings.

There are two kinds of resets:

- **Soft Reset** – Just a simple power cycle will reset all settings that were previously set via the rear panel and/or app back to their default settings (except for Bluetooth and linked speakers that are stored within ThumpXT).
- **Hard Reset** – A hard reset resets the entire unit to its factory default, including auto-connect and auto-link. A hard reset may be accomplished by pressing and holding down the 'Voicing Modes' and 'Outdoor Mode' buttons simultaneously for approximately five seconds on boot up. Release the buttons when multiple voicing mode LEDs light up simultaneously, as this indicates success.



Please keep in mind that this erases all settings, including any levels, EQs, etc. that may have been set. Be sure to power down any amps and/or powered speakers before resetting ThumpXT.



If you use the factory default key combination, you are also wiping the ThumpXT's memory of previously paired devices. To remedy this, on your phone, tablet or other Bluetooth device, you will need to 'forget device' in the Bluetooth settings, then re-pair in order to regain communication and functionality.

Protection Circuitry

ThumpXT loudspeakers employ a built-in limiter for less distortion at peak levels. A dynamic bass response circuit provides optimal low frequency response regardless of overall output level. Additional protection includes automatic thermal shutdown should the amp overheat. However, with Class-D amp technology, which is highly-efficient, this should never be a problem.



The protection circuits are designed to protect the loudspeakers under reasonable and sensible conditions. Should you choose to ignore the warning signs [e.g. excessive distortion], you can still damage the woofer in the loudspeaker by overdriving it past the point of amplifier clipping. Such damage is beyond the scope of the warranty.

Limiting

The polymer high frequency driver has its own compression circuit which helps protect it from damaging transient peaks. The compressor is designed to be transparent and is not noticeable under normal operating conditions.

Overexcursion Protection

A subsonic filter circuit just prior to the power amplifier prevents ultra-low frequencies from being amplified. Excessive low-frequency energy can damage the woofer by causing it to “bottom out,” also known as overexcursion, which is equivalent to a mechanical form of clipping.

Thermal Protection

All amplifiers produce heat. ThumpXT loudspeakers are designed to be efficient both electrically and thermally. In the unlikely event of the amplifier overheating, a built-in thermal switch will activate, muting the signal.

When the amplifier has cooled down to a safe operating temperature, the thermal switch resets itself, and the ThumpXT loudspeaker resumes normal operation.

If the thermal switch activates, try turning down the level control a notch or two on the mixing console to avoid overheating the amplifier. Be aware that direct sunlight and/or hot stage lights may be the culprit of an amplifier overheating.

AC Power

Be sure the ThumpXT loudspeaker is plugged into an outlet that is able to supply the correct voltage specified for your model. It will continue to operate at lower voltages, but will not reach full power. Be sure the electrical service can supply enough amperage for all the components connected to it.

We recommend that a stiff (robust) supply of AC power be used because the amplifiers place high current demands on the AC line. The more power that is available on the line, the louder the speakers will play and the more peak output power will be available for a cleaner, punchier bass. A suspected problem of “poor bass performance” is often caused by a weak AC supply to the amplifiers.



Never remove the ground pin on the power cord or any other component of the ThumpXT loudspeaker. This is very dangerous.

Care and Maintenance

Your ThumpXT loudspeakers will provide many years of reliable service if you follow these guidelines:

- Avoid exposing the loudspeakers to moisture. If they are set up outdoors, be sure they are under cover if rain is expected.
- Avoid exposure to extreme cold (below freezing temperatures). If you must operate the loudspeakers in a cold environment, warm up the voice coils slowly by sending a low-level signal through them for about 15 minutes prior to high-power operation.
- Use a dry cloth to clean the cabinets. Only do this when the power is turned off. Avoid getting moisture into any of the openings of the cabinet, particularly where the drivers are located.

Placement



WARNING: Installation should only be done by an experienced technician. Improper installation may result in damage to the equipment, injury or death. Make sure that the loudspeaker is installed in a stable and secure way in order to avoid any conditions that may be dangerous for persons or structures.

ThumpXT loudspeakers are designed to sit on the floor or stage as the main PA or as monitors. They may also be pole-mounted via the built-in socket on the bottom of the cabinet. Be sure the pole is capable of supporting the weight of the loudspeaker. The T100 is a great tripod option and the SPM400 is a nice choice when using a subwoofer.

These loudspeakers may also be flown via their integrated fly points as detailed on the following page. Be sure to read the PA-A2 Eyebolt Installation Instructions, as well.



NEVER attempt to suspend a Thump loudspeaker by its handles.

Check to make sure that the support surface (e.g. floor, etc.) has the necessary mechanical characteristics to support the weight of the loudspeaker(s).

When pole-mounting loudspeakers, be sure that they are stabilized and secured from falling over or being accidentally pushed over. Failure to follow these precautions may result in damage to the equipment, personal injury, or death.

Thump loudspeakers may be laid out horizontally as monitors for the band at a 40° angle (as seen below). It is intended to be used only when the speaker is in its wedge configuration and works best when on a hard work surface, like a stage.

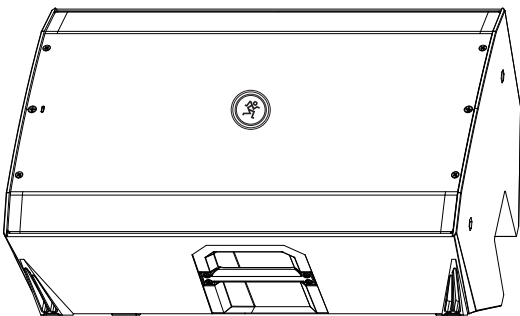

As seen above, the Running Man logo is rotatable for when the loudspeaker is used as a monitor!

Room Acoustics

ThumpXT loudspeakers are designed to sound fantastic in nearly every application.

But, room acoustics play a crucial role in the overall performance of a sound system. However, the wide high-frequency dispersion of the ThumpXT loudspeakers helps to minimize the problems that typically arise.

Here are some additional placement tips to help overcome some typical room problems that might arise:

- Placing loudspeakers in the corners of a room increases the low frequency output and can cause the sound to be muddy and indistinct.
- Placing loudspeakers against a wall increases the low frequency output, though not as much as corner placement. However, this is a good way to reinforce the low frequencies, if so desired.
- Avoid placing the speakers directly on a hollow stage floor. A hollow stage can resonate at certain frequencies, causing peaks and dips in the frequency response of the room. It is better to place them on a sturdy stand designed to handle the weight of the loudspeaker.
- Position the loudspeakers so the high-frequency drivers are two to four feet above ear level for the audience (making allowances for an audience that may be standing/dancing in the aisles). High frequencies are highly directional and tend to be absorbed much easier than lower frequencies. By providing direct line-of-sight from the loudspeakers to the audience, you increase the overall brightness and intelligibility of the sound system.
- Highly reverberant rooms, like many gymnasiums and auditoriums, are a nightmare for sound system intelligibility. Multiple reflections off the hard walls, ceiling, and floor play havoc with the sound. Depending on the situation, you may be able to take some steps to minimize the reflections, such as putting carpeting on the floors, closing draperies to cover large glass windows, or hanging tapestries or other materials on the walls to absorb some of the sound.

However, in most cases, these remedies are not possible or practical. So what do you do? Making the sound system louder generally doesn't work because the reflections become louder, too. The best approach is to provide as much direct sound coverage to the audience as possible. The farther away you are from the speaker, the more prominent will be the reflected sound.

Use more speakers strategically placed so they are closer to the back of the audience. If the distance between the front and back speakers is more than about 100 feet, you should use an external delay processor to time-align the sound. (Since sound travels about 1 foot per millisecond, it takes about 1/10 of a second to travel 100 feet.)

Keep in mind that the voicing mode is another great way to compensate for some of these issues. See page 12 for more information.

Rigging



WARNING: Installation should only be done by an experienced technician. Improper installation may result in damage to the equipment, injury or death. Make sure that the loudspeaker is installed in a stable and secure way in order to avoid any conditions that may be dangerous for persons or structures.



WARNING: The cabinet is suitable for rigging via its fly points. NEVER attempt to suspend a ThumpXT loudspeaker by its handle(s).

The fly points are shown below, while an example of a flown ThumpXT is displayed below-right.



ThumpXT loudspeakers may only be flown vertically.

Rigging Design Practices

Rigging a loudspeaker requires determining:

1. The rigging methods and hardware that meet static, shock, dynamic, and any other load requirements for supporting the loudspeaker from structure.
2. The design factor and required WLL (Working Load Limit) for this support.

We strongly recommend the following rigging practices:

1. Documentation: Thoroughly document the design with detailed drawings and parts lists.
2. Analysis: Have a qualified professional, such as a licensed Professional Engineer, review and approve the design before its implementation.
3. Installation: Have a qualified professional rigger do the installation and inspection.
4. Safety: Use adequate safety precautions and back-up systems.

ThumpXT Fly Points

MP = Mounting Point

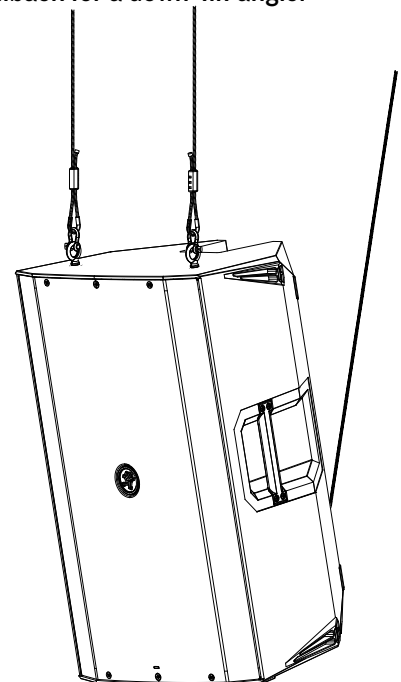
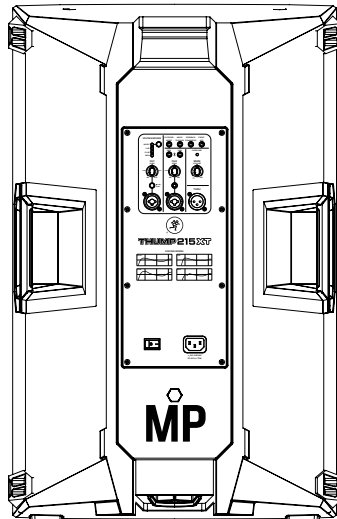
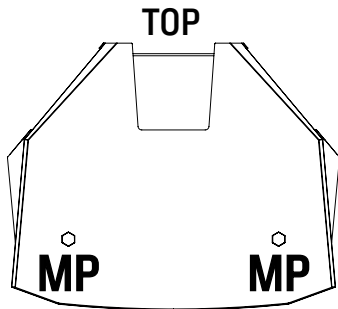

Rigging Hardware and Accessories

Rigging our loudspeakers will invariably require hardware not supplied by us. Various types of load-rated hardware are available from a variety of third-party sources. There are a number of such companies specializing in manufacturing hardware for designing and installing rigging systems. Each one of these tasks is a discipline in its own right. Because of the hazardous nature of rigging work and the potential liability, engage companies that specialize in these disciplines to do the work required.

We do offer certain accessory rigging items and some of them may be used with a variety of products. While these accessories are intended to facilitate installation, the wide variety of possible installation conditions and array configurations do not permit us to determine their suitability or load rating for any particular application.

We are not in the business of providing complete rigging systems, either as designers, manufacturers, or installers. It is the responsibility of the installer to provide a properly engineered, load-certified rigging system for supporting the loudspeaker from structure.



ThumpXT loudspeakers may be individually flown using a PA-A2 Eyebolt Kit, part number 2051054.

Rigging Notes

The ThumpXT loudspeaker's integral mounting points are designed to support only the weight of their own loudspeaker with suitable, external hardware. This means that each ThumpXT loudspeaker must be supported independently of any other ThumpXT loudspeaker and any other loads. At least the top two rigging points must be used to hang each ThumpXT loudspeaker. The rear / bottom one helps with an even vertical hang or pullback for a down-tilt angle.

Appendix A: Service Information

If you think your ThumpXT has a problem, please check out the following troubleshooting tips and do your best to confirm the problem. Visit the Support section of our website (www.mackie.com/support) where you will find lots of useful information such as FAQs and other documentation. You may find the answer to the problem without having to part with your ThumpXT.

Troubleshooting

No power

- Our favorite question: Is it plugged in? Make sure the AC outlet is live [check with a tester or lamp].
- Our next favorite question: Is the power switch on? If not, try turning it on.
- Make sure the line cord is securely seated in the line cord socket and plugged all the way into the AC outlet.
- Is the power LED on the front panel illuminated? If not, make sure the AC outlet is live. If so, refer to “No sound” below.
- The internal AC line fuse may be blown. This is not a user serviceable part. If you suspect the AC line fuse is blown, please see the “Repair” section next.

No sound

- Is the level knob for the input source turned all the way down? Verify that all the volume controls in the system are properly adjusted. Look at the level meter to ensure that the mixer is receiving a signal.
- Is the signal source working? Make sure the connecting cables are in good repair and securely connected at both ends. Make sure the output level control on the mixing console is turned up sufficiently to drive the inputs of the speaker.
- Make sure the mixer does not have a mute on or a processor loop engaged. If you find something like this, make sure the level is turned down before disengaging the offending switch.
- Has it shut down? Make sure there is at least six inches of free space behind each ThumpXT.

Poor sound

- Is it loud and distorted? Make sure that you're not overdriving a stage in the signal chain. Verify that all level controls are set properly.
- Is the input connector plugged completely into the jack? Be sure all connections are secure.
- Are there phasing issues? The signal source should only be connected to a single input. For example, do not connect the L/R outputs from a mixer to the ThumpXT channel 1 and 2 inputs. Do not use a Y cable to split a phone's signal, use both outputs of a stereo synth (which sums to mono, anyway), etc.

Noise

- Make sure all connections to the ThumpXT are good and sound.
- Make sure none of the signal cables are routed near AC cables, power transformers, or other EMI-inducing devices.
- Is there a light dimmer or other SCR-based device on the same AC circuit as the ThumpXT? Use an AC line filter or plug the loudspeaker into a different AC circuit.

Hum

- Try disconnecting the cable connected to the input jack. If the noise disappears, it could be a “ground loop,” rather than a problem with the ThumpXT. Try some of the following troubleshooting ideas:
 - Use balanced connections throughout your system for the best noise rejection.
 - Whenever possible, plug all the audio equipment's line cords into outlets which share a common ground. The distance between the outlets and the common ground should be as short as possible.

Bluetooth / Linking Issues

- Sometimes a good 'ol fashioned reset works wonders. There are two types, soft and hard. See page 15 for more info on resetting ThumpXT.
- Try linking two ThumpXT loudspeakers together prior to connecting via Bluetooth.
- Be sure to connect the Bluetooth device to the primary ThumpXT loudspeaker.

Other Issues

- Please email or call Technical Support if you are having any other issue not listed here:
 - o mackie.com/support-contact
 - o 1-800-898-3211

Repair

For warranty service, refer to the warranty information on page 23.

Non-warranty service is available at a factory-authorized service center. To locate the nearest service center, visit www.mackie.com/support/service-locator. Service for ThumpXTs living outside the United States may be obtained through local dealers or distributors.

If you do not have access to our website, please call our Tech Support department at 1-800-898-3211 (normal business hours, Pacific Time), to explain the problem. They will tell you where the nearest factory-authorized service center is located in your area.

Appendix B: Technical Information

ThumpXT Loudspeakers Specifications

Acoustic Performance

Frequency Range (-10 dB)	47 Hz – 23 kHz [Thump212XT] 40 Hz – 23 kHz [Thump215XT]
Frequency Range (-3 dB)	54 Hz – 20 kHz [Thump212XT] 47 Hz – 20 kHz [Thump215XT]
Horizontal Coverage Angle	90°
Vertical Coverage Angle	60°
Maximum SPL Peak	128 dB [Thump212XT] 129 dB [Thump215XT]
Monitor Angle	40°

Transducers

Low Frequency	12 in / 305 mm [Thump212XT] 15 in / 381 mm [Thump215XT] with ferrite
High Frequency	1.0 in / 25 mm polymer compression driver

Power Amplifiers

System Power Amplification	
Rated Power	1400 watts peak
Low Frequency Power Amplifier	
Rated Power	1200 watts peak
Rated THD	< 1%
Cooling	Convection
Design	Class D
High Frequency Power Amplifier	
Rated Power	200 watts peak
Rated THD	< 1%
Cooling	Convection
Design	Class D

System Processing

Voicing	Four speaker modes
---------	--------------------

Input/Output

Input Type	2x Female XLR – 1/4" Balanced TRS combo jack and 1/8" TRS
Mic/Line Impedance	10 kΩ Balanced
1/8" Line Impedance	10 kΩ Balanced
Thru Out	Male XLR Balanced
Thru Out Impedance	300 Ω Balanced

Electronic Crossover

Crossover Frequency	2.1 kHz
---------------------	---------

Line Input Power

Detachable line cord	100–240V~, 50–60 Hz, 75W
AC Connector	3-pin IEC 250 VAC, 10 A male
Power Supply Type	Switchmode

Safety Features

Input Protection	Peak and RMS limiting, power supply and amplifier thermal protection
Display LEDs	Voicing Mode, Outdoor Mode, Music Ducking, Feedback Eliminator, Front LED, Bluetooth Status, Link Status, Overload

Physical Properties

Thump212XT:	
Height:	24.4 in / 620 mm
Width:	14.0 in / 356 mm
Depth:	14.0 in / 356 mm
Weight:	27.6 lb / 12.5 kg

Thump215XT:	
Height:	27.4 in / 696 mm
Width:	17.3 in / 439 mm
Depth:	14.0 in / 356 mm
Weight:	32.6 lb / 14.8 kg

Mounting Methods:

Floor mount, pole mount via the built-in socket on the bottom of the cabinet [Be sure the pole is capable of supporting the weight of the ThumpXT loudspeaker] or fly via the integrated M10 mounting points (using M10 x 1.5 x 20 mm forged shoulder eyebolts).

See pages 16–17 for more information.

Options

Thump212XT Speaker Bag	P/N 2047360-09
Thump212XT Rolling Speaker Bag	P/N 2047360-10
Thump215XT Speaker Bag	P/N 2047360-11
Thump215XT Rolling Speaker Bag	P/N 2047360-12
T100 Loudspeaker Tripod Stand	P/N 2052464
SPM400 Loudspeaker Pole Mount	P/N 2051055
PA-A2 Forged Shoulder Eyebolt Kit (3 x M10 x 1.5 x 20 mm)	P/N 2051054

Disclaimer

Since we are always striving to make our products better by incorporating new and improved materials, components, and manufacturing methods, we reserve the right to change these specifications at any time without notice.

The "Running Man" figure is a registered trademark of LOUD Audio, LLC.

All other brand names mentioned are trademarks or registered trademarks of their respective holders, and are hereby acknowledged.

©2024 LOUD Audio, LLC. All Rights Reserved.

Thump212XT Dimensions

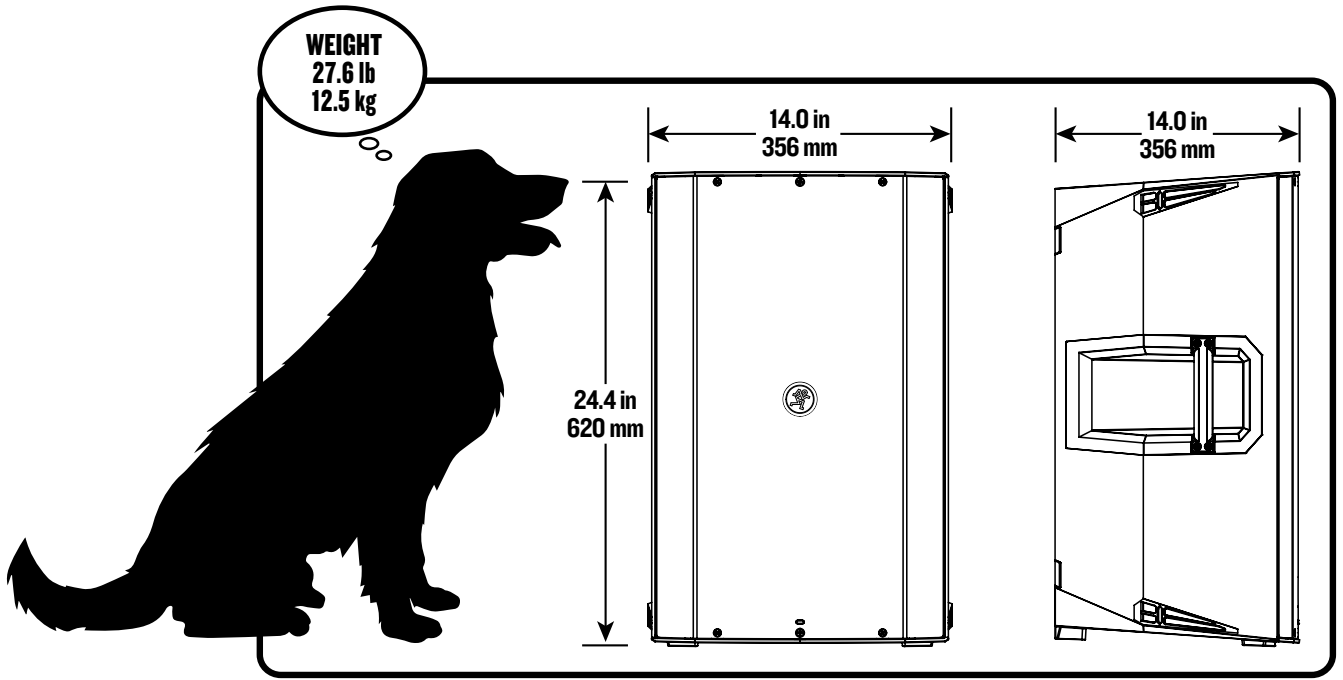

Thump215XT Dimensions

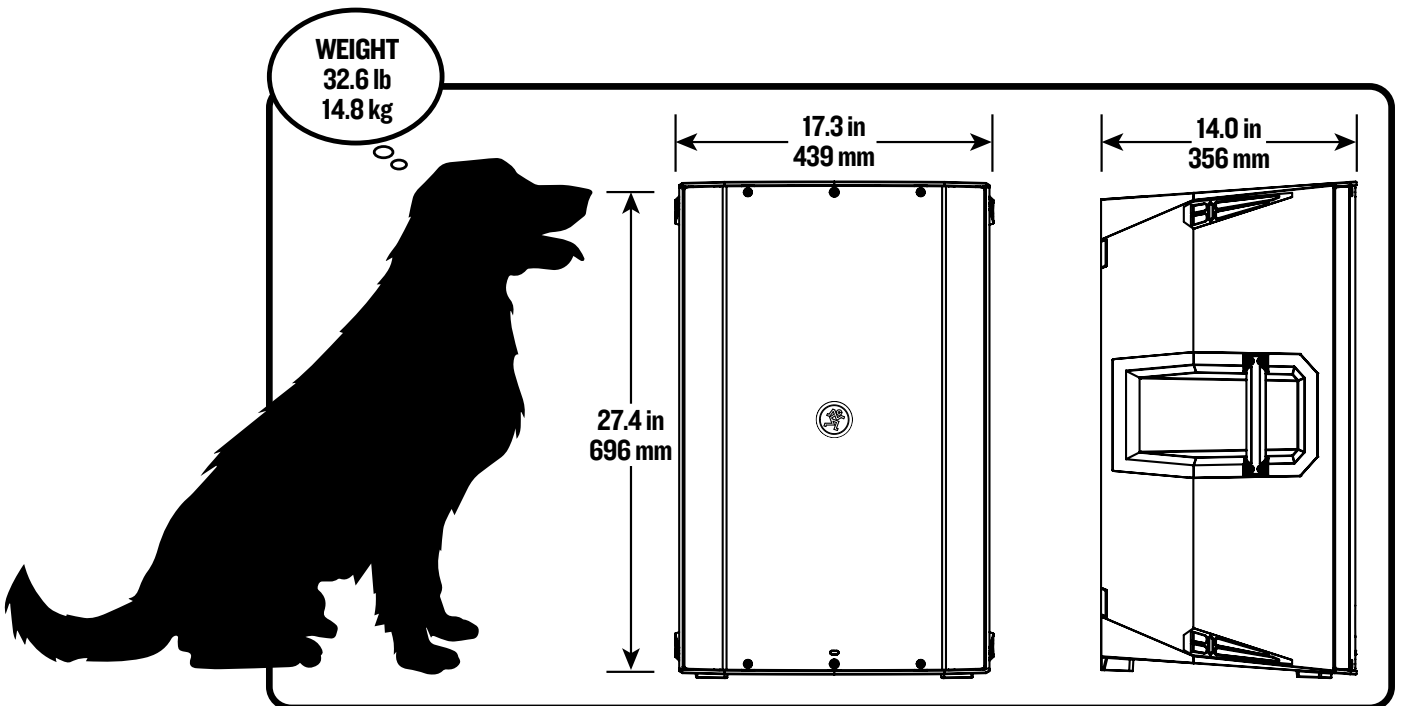

ThumpXT Block Diagram

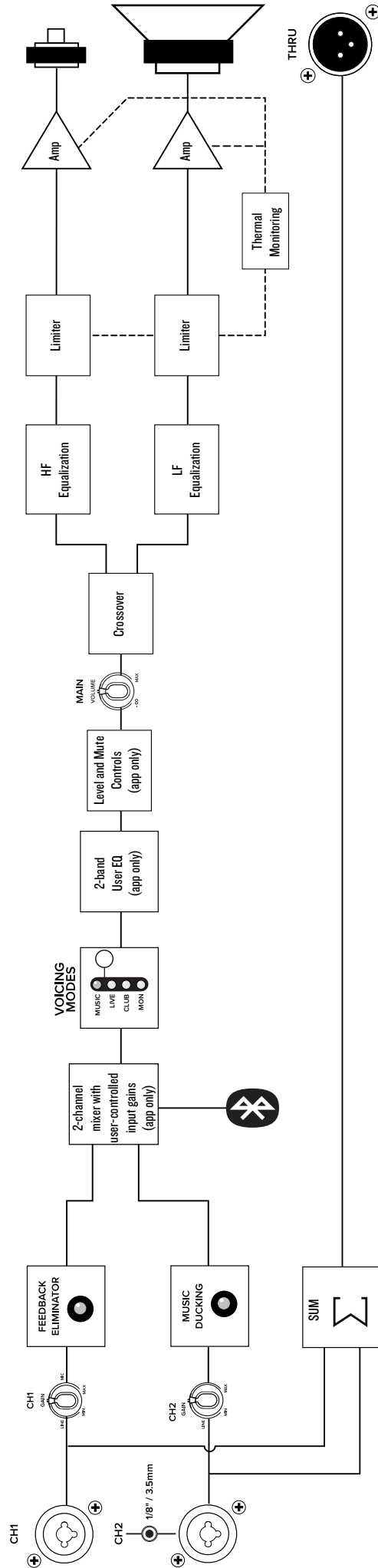

Limited Warranty

Please keep your sales receipt in a safe place.

This Limited Product Warranty ("Product Warranty") is provided by LOUD Audio, LLC ("LOUD") and is applicable to products purchased in the United States or Canada through a LOUD-authorized reseller or dealer. The Product Warranty will not extend to anyone other than the original purchaser of the product (hereinafter, "Customer," "you" or "your").

For products purchased outside the U.S. or Canada, please visit www.mackie.com to find contact information for your local distributor, and information on any warranty coverage provided by the distributor in your local market.

LOUD warrants to Customer that the product will be free from defects in materials and workmanship under normal use during the Warranty Period. If the product fails to conform to the warranty then LOUD or its authorized service representative will at its option, either repair or replace any such nonconforming product, provided that Customer gives notice of the noncompliance within the Warranty Period to the Company at: www.mackie.com or by calling LOUD technical support at 1.800.898.3211 (toll-free in the U.S. and Canada) during normal business hours Pacific Time, excluding weekends or LOUD holidays. Please retain the original dated sales receipt as evidence of the date of purchase. You will need it to obtain any warranty service.

For full terms and conditions, as well as the specific duration of the Warranty for this product, please visit www.mackie.com.

The Product Warranty, together with your invoice or receipt, and the terms and conditions located at www.mackie.com constitutes the entire agreement, and supersedes any and all prior agreements between LOUD and Customer related to the subject matter hereof. No amendment, modification or waiver of any of the provisions of this Product Warranty will be valid unless set forth in a written instrument signed by the party to be bound thereby.

Need help with the ThumpXT Loudspeakers?

- Visit www.mackie.com/support to find: FAQs, manuals, addendums, and other documents.
- Email us at: www.mackie.com/support-contact
- Telephone 1-800-898-3211 to speak with one of our splendid technical support chaps (Monday through Friday, normal business hours, Pacific Time).



**19820 North Creek Parkway #201
Bothell, WA 98011 • USA
Phone: 425.487.4333
Toll-free: 800.898.3211
Fax: 425.487.4337
www.mackie.com**
